

DRIPPING SPRINGS LIGHTING PLAN SUBMISSION CHECKLIST

Key Requirements – Refer to the Ordinance for Specifics

- (1) All outdoor lighting shall be shielded so that the light source (the bulb or a light colored lens is not visible from any other property. Mounting height or proximity to property lines may cause you to need added shielding. (See Figures A, B & C)
- (2) Light is measured in lumens. Commercial properties are allowed 100,000 lumens per net acre (about 2.2957 lumens/sq. ft.) and residential properties are allowed 25,000 lumens per net acre (about 0.57392 lumens/sq. ft) in any contiguous illuminated area.
- (3) Outdoor lighting includes light fixtures installed indoors behind see-through material that allows the light source to be seen from any other property.

Items to include in Lighting Plan for all Outdoor Lighting:

- _____ (1) The location and height of all existing and proposed light fixtures. Data for existing fixtures may be estimated but the source of the numbers assigned must be documented.
- _____ (2) Manufacturer’s specification sheets for each fixture included in the plan. The specific configuration and any options to be ordered should be indicated on the spec sheet. If specification sheets cannot be located for an existing fixture, then submit daylight photographs of it and nighttime photographs showing the area the fixture illuminates.
- _____ (3) Building elevations with notes where light fixtures are to be installed indoors which may be seen from the exterior.
- _____ (4) Site plan with specific measurements in feet for the area to be illuminated. A scale notation is not sufficient.
- _____ (5) A completed Lumen Calculation Workbook (Excel format) to determine net lumens per square foot (See Figure D). It must include:
 - _____ (A) The light fixture catalog descriptions including lamp type
 - _____ (B) The Kelvin rating for the selected lamp
 - _____ (C) The B-U-G rating for the selected fixture, if available
 - _____ (D) The mounting height for the fixture
 - _____ (E) The number of fixtures / lamps (use the same unit corresponding to the unit used to determine how many lumens are produced)
 - _____ (F) The initial lumens for each entire fixture
 - _____ (G) The relative mounting location if the fixture is mounted under a canopy. If mounted under a canopy and the closest edge is less than 5 feet, enter 1; between 5 and 10 feet enter 0.25; more than 10 feet from the closest edge enter 0.1. (See Figure E)
 - _____ (H) The LLF or efficiency for the calculation of Luminaire Lumens (Use 0.95 for LEDs and 0.80 for other types of lamps unless a different percentage is documented in manufacturer’s data).
 - _____ (I) The total square footage of the area to be illuminated.

FIGURES AND ILLUSTRATIONS

FIGURE A:

This figure shows examples of fixtures that are Fully Shielded because they are closed on top and mounted such that the bottom opening is horizontal.

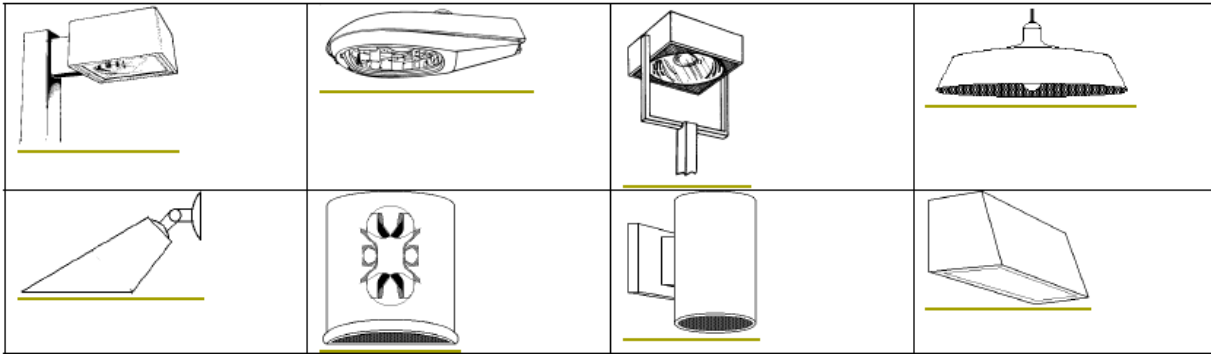

FIGURE B:

Example of Fully Shielded fixture with additional shielding below the horizontal lens.



FIGURE C:

Unacceptable / Do Not Use

Fixtures that produce glare and light trespass

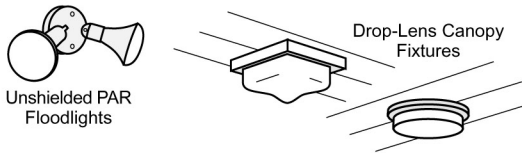
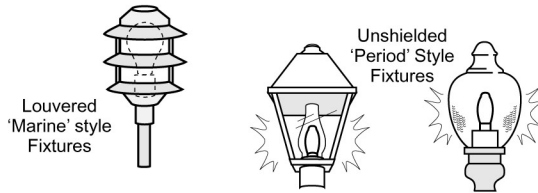
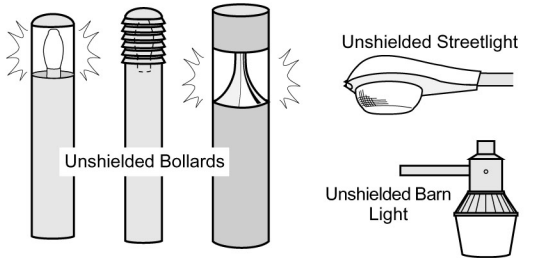
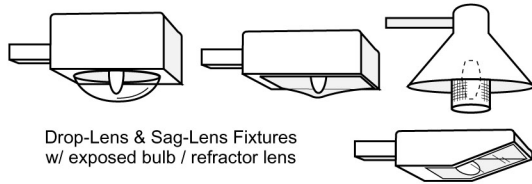
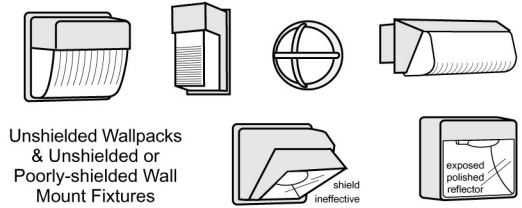
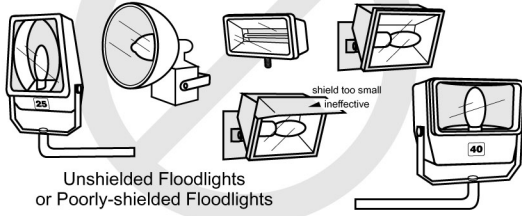

Usually Acceptable / May Need Shielding

Fixtures that shield the light source to minimize glare and light trespass and to facilitate better vision at night

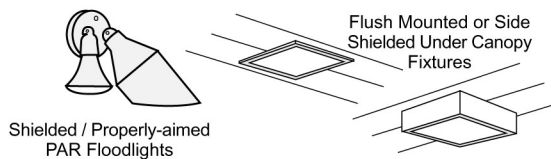
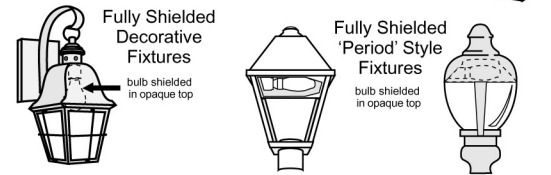
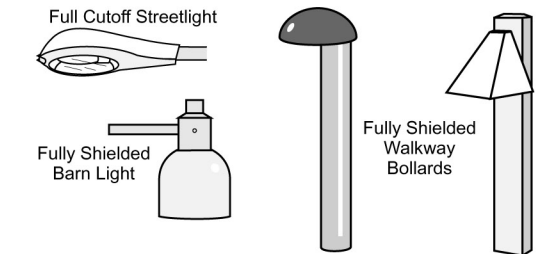
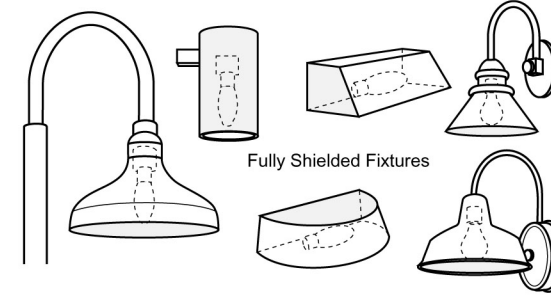
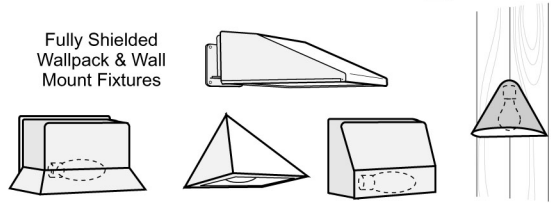
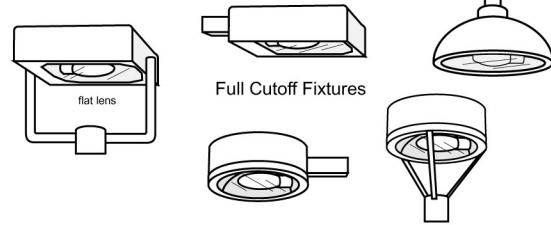

FIGURE D: Sample Lumen Calculation Sheet (Excel sample available on City website)

Lumen Compliance Chart: Sample (Put Project Name Here)										
Luminaire Schedule Lumens										
Lamp Description	Label	Kelvin	B-U-G Rating	Mtg Height	# Lamps	Initial Lumens	Loc*	LLF**	Total	Other Notes
1A-1521FLED-EZ-FG-6ARC27T2	A	2700	B1-U0-G1	20 ft	6	6,700	1.00	0.95	38,190.00	
PA230N/ROH/FG/PB 100MHP	B	3000	B1-U0-G1	12 ft	8	7,900	1.00	0.80	50,560.00	
WST LED 1 10A700/30K SR3 MVOLT	C	3000	B1-U0-G1	8 ft	4	2,029	1.00	0.95	7,710.20	
KRB-60L-40D-30K-SSGC-FF: 12 feet back	D	3000	B0-U0-G0	under canopy	3	6,000	0.10	0.95	1,710.00	Under loading dock canopy
KRB-60L-40D-30K-SSGC-FF: 7 ft back	E	3000	B0-U0-G0	under canopy	6	6000	0.25	0.95	8,550.00	Under front canopy
Total Initial Luminaire Lumens									106,720.20	
Site Allowed Total Initial Lumens									114,785.00	
Is Project Compliant?									Yes!	
Illuminated Acres (Note 1 acre = 43,560 sq ft)										
Allowance Description	Square Feet	Allowed per Sq Ft	Allowed							
Square footage of site including buildings (when entire site is to be illuminated) See Site Sq Ft Note below.	57000									
Square footage of building footprints	7000									
Square footage of area to be illuminated	50000	2.2957	114,785.00							
Site Allowed Total Initial Lumens			114,785.00							
*Loc = Location from edge of canopy. Normal value is 1. If lamp is located between 5 & 10 feet from nearest canopy edge use 0.25. If located 10 feet or more from nearest edge use 0.10.										
** LLF = Use efficiency defined by manufacturer If efficiency unknown, use 1.0 for LEDs. If unknown for non-solid state (non-LED) lamps use 0.80										
Site Sq Ft Note: Only the outdoor area to be illuminated may be included in the square footage used to determine site allowed total initial lumens. This is often easiest to calculate by starting with the square footage of the site and subtracting the buildings. That's what is being done here. Check with your lighting reviewer if you have questions.										

FIGURE E:

Plan and elevation views of a canopy or overhang attached to a building, showing location of shielded fixtures and initial lamp output percentage counted toward total lumens.

